



Wochenplan vom 14.12.2020 bis 18.12.2020

01.02 - 05.02.2021

Name: _____



Thema der Woche: Im Winter Klasse 2a, 2b

	Pflicht/ Wahl	Aufgabe	✓	
😊	P	Sprachfreunde 5 min. Training S. 22 bis 25		
😊	P	Sprachfreunde AH S. 32, 33		
😊😊	P	Suche dir einen Partner und lies: Lesefreunde S. 90		
😊	P	Umweltfreunde S. 62 / Ausschneidebogen auf S. 95		
😊	P	Geometrie (für alle) AH - klein S. 27, 28, 29		
😊	P	Add./Subtr. Für die guten Rechenmäuse AH - klein S. 31, 36, 37		
😊	P	Für die noch besseren Rechenmäuse AH - klein S. 35, 36, 37		
😊	P	Wer die Aufgaben schon erledigt hat, kann auch im AH (groß) S.36 u. 37 rechnen!		
		Arbeitsblätter (Konzentration) für ganz Fleißige!		

Hinweis: 1. Vielleicht findet ihr ein Video über die Feuerwehr auf unserer
Internetseite (Zum Bsp. „Wissen macht ah.)

2. Wenn ihr nicht alles schafft ist das kein Problem.

Viel Spaß (hoffentlich) eure Lehrerinnen Frau Ulrich und Frau Meyer

1 Aus welchen Teilen lässt sich die Figur nachbauen?

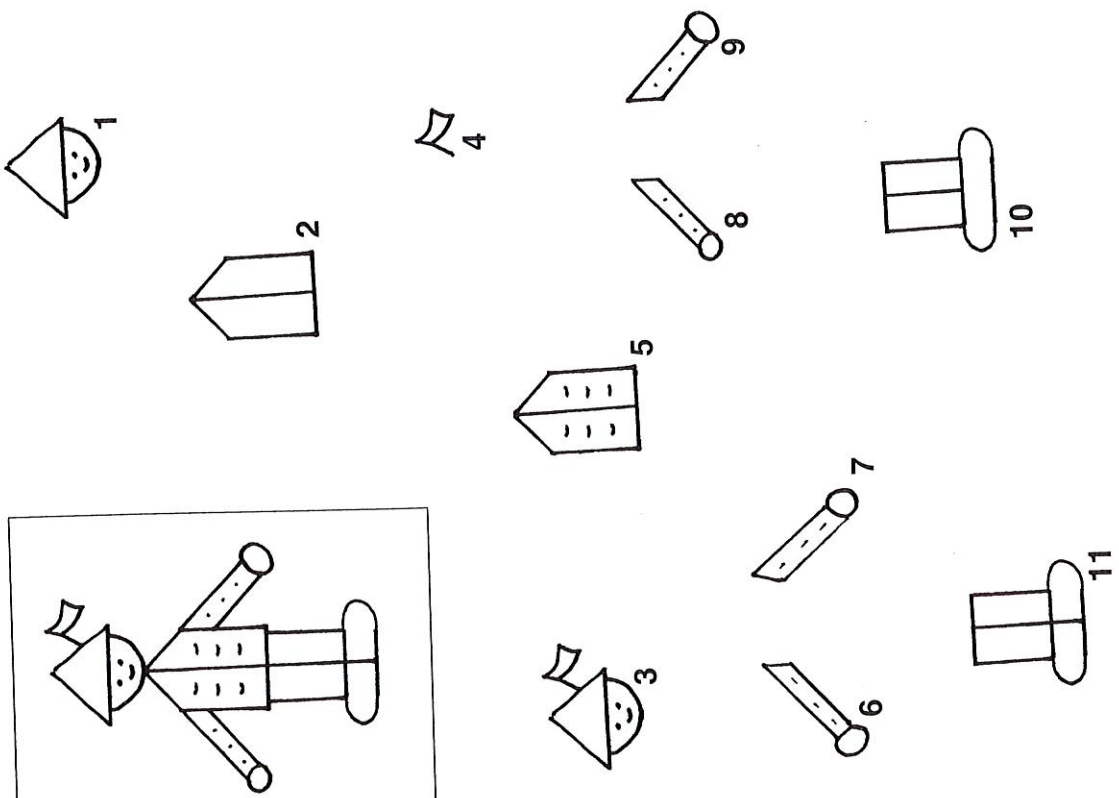
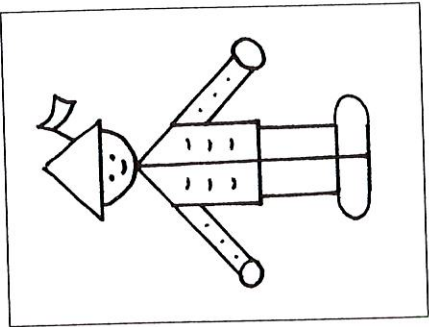

1 Aus welchen Teilen lässt sich das Schiff nachbauen?

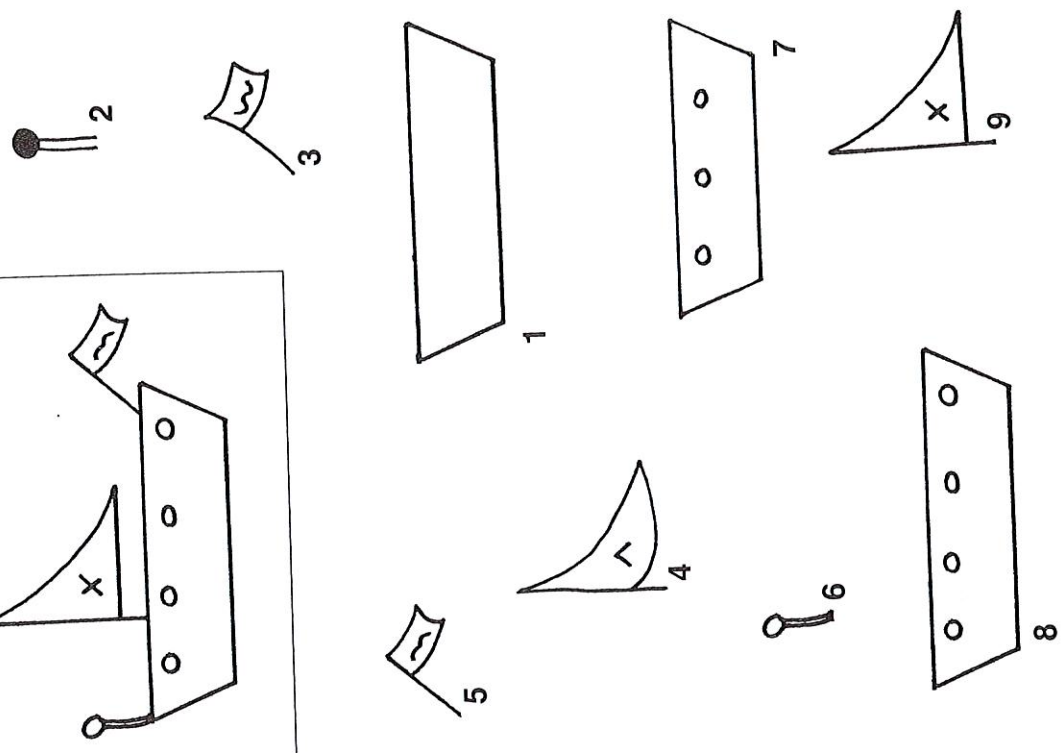
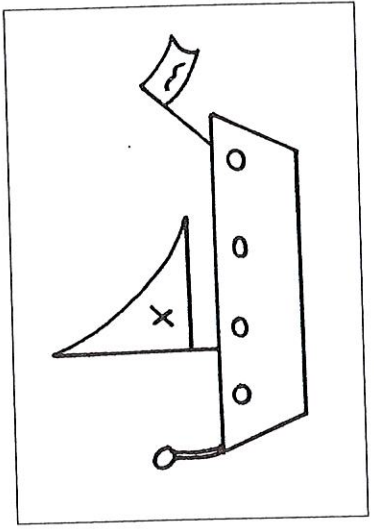



1 Aus welchen Teilen lässt sich das Haus nachbauen?

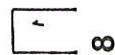
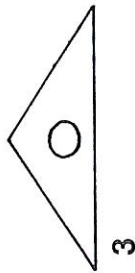
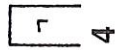
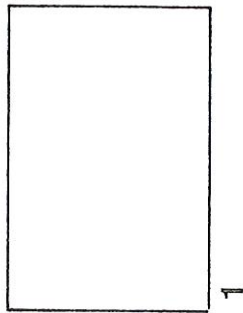
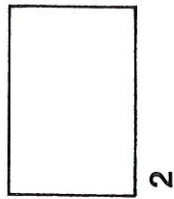
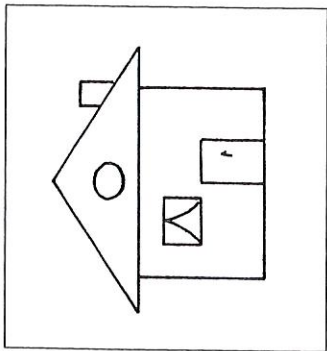

10

8

1 Aus welchen Teilen lässt sich die Burg nachbauen?

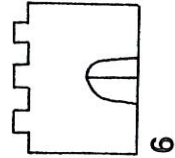
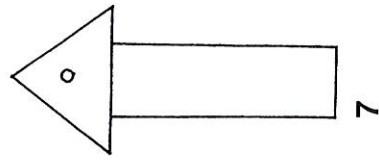
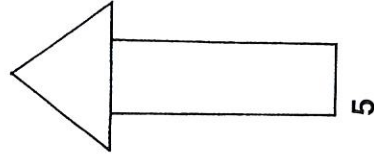
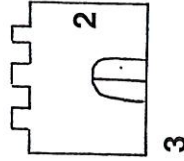
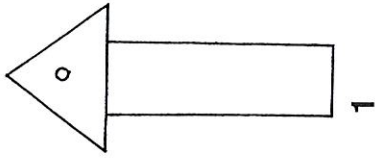
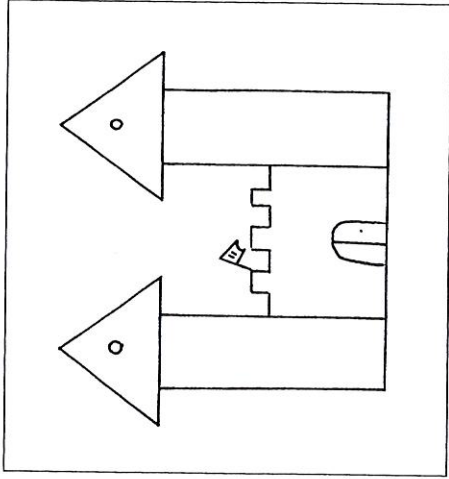

5

3

4

6

7

2 Groß, kleiner, am kleinsten

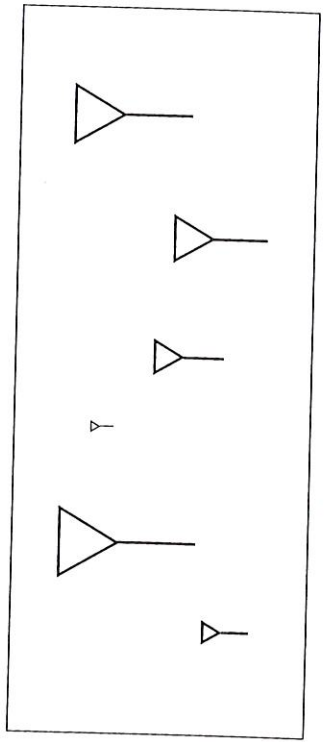
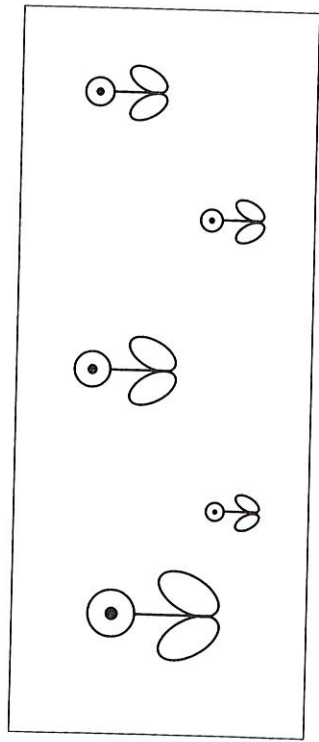
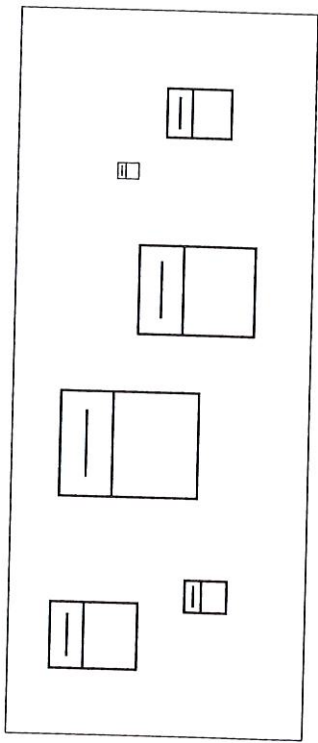

2 Groß, kleiner, am kleinsten

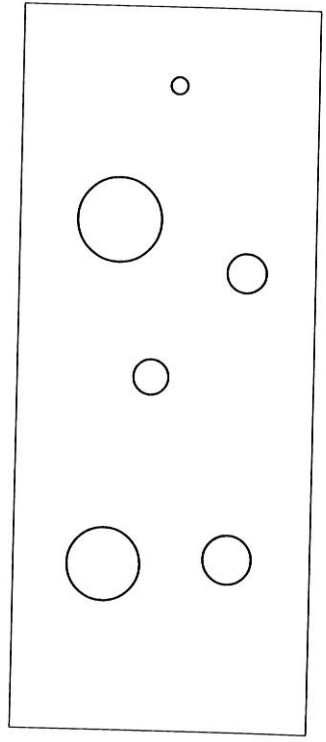
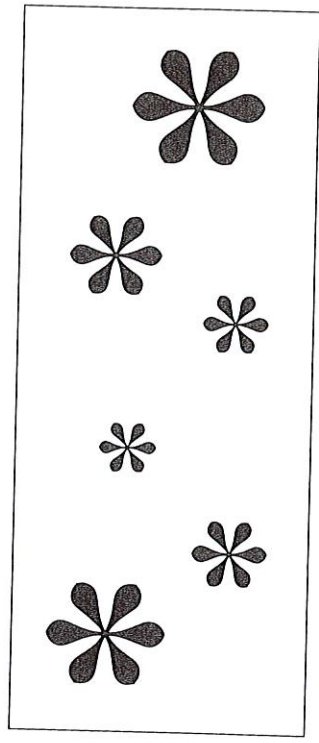
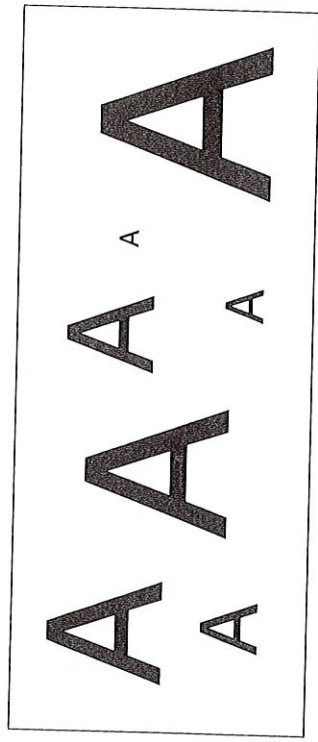

2 Groß, kleiner, am kleinsten

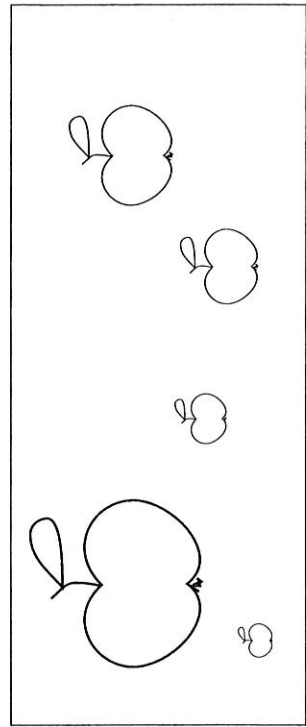
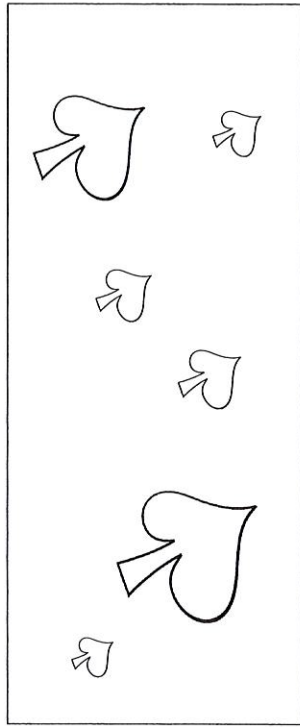
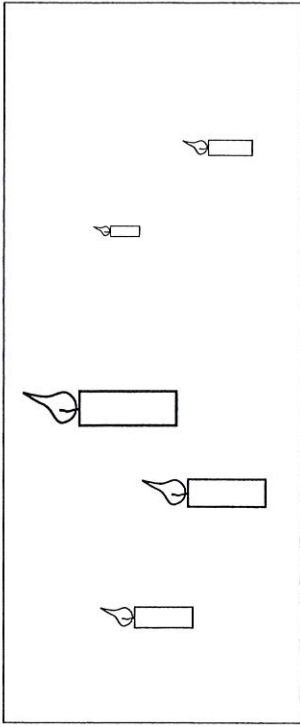

2 Groß, kleiner, am kleinsten

